

Article number: 204250M1280A0SK
 Description: E+G levelling foot
 GN 42-50-M12-80-A0-SK
 Note: SK With nut, External hexagon at the bottom

Measures

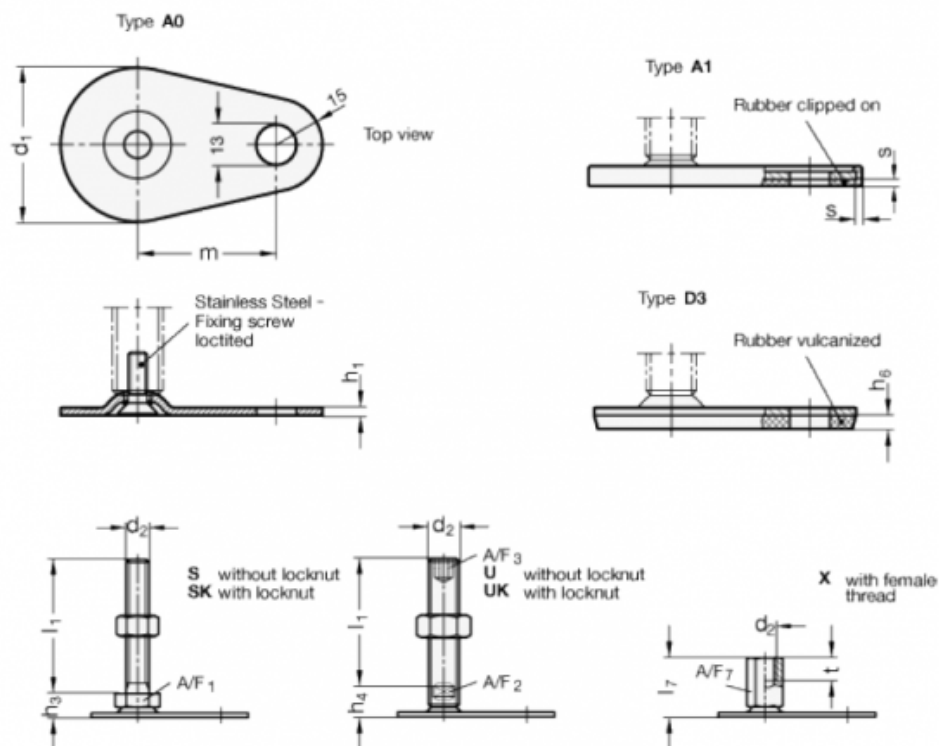

A/F1 = 17
 d_1 = 50
 d_2 = M12
 h_1 = 2.5
 h_3 = 11
 h_6 =
 h_1 = 80
 m = 45

s =